

TS Metals

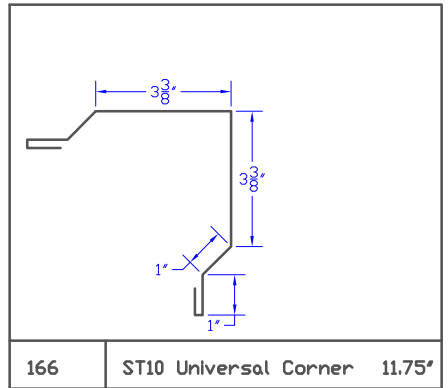

TS Metals

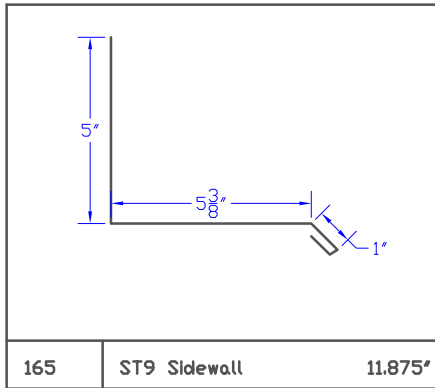
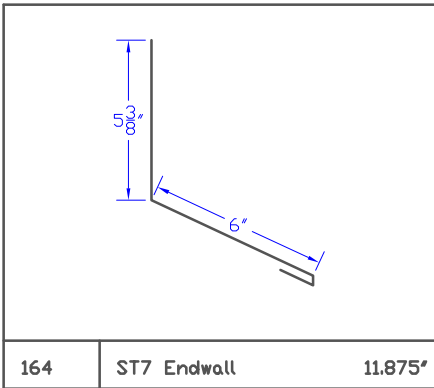
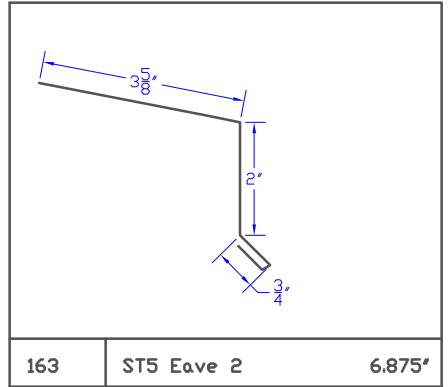
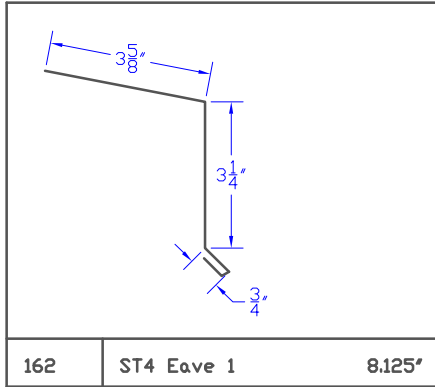
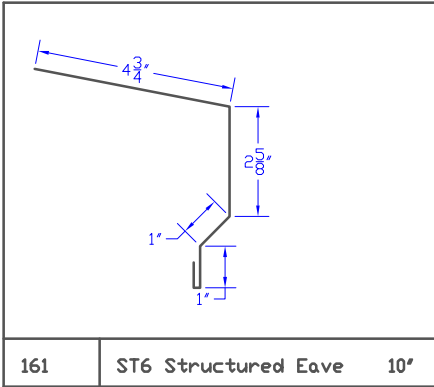
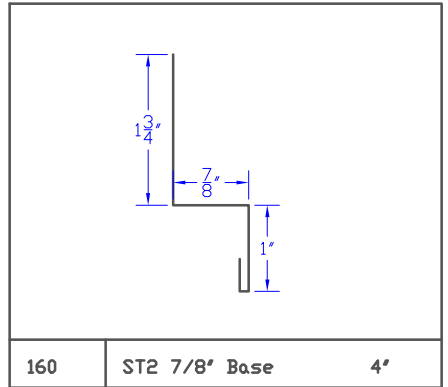
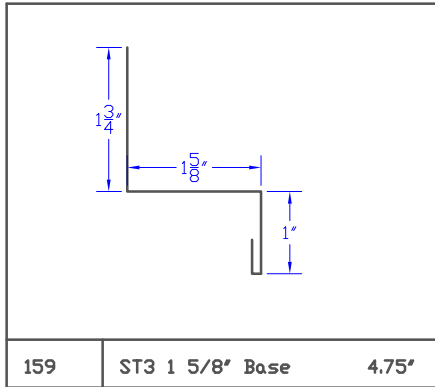
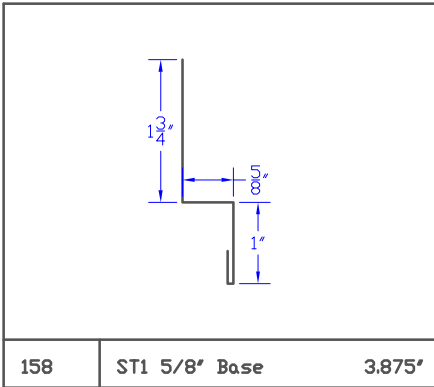
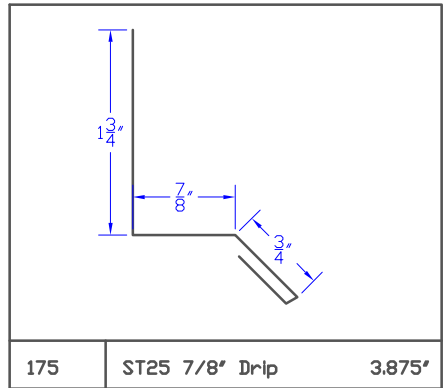
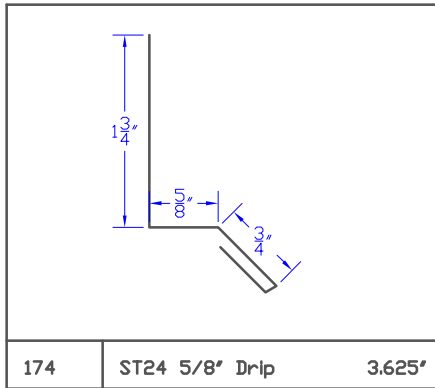
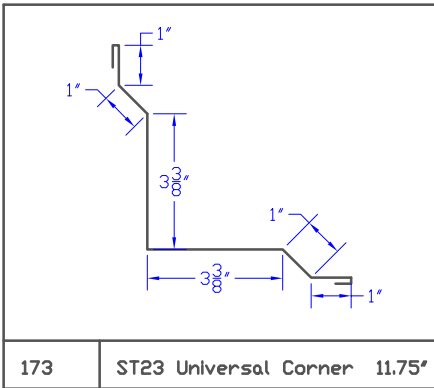
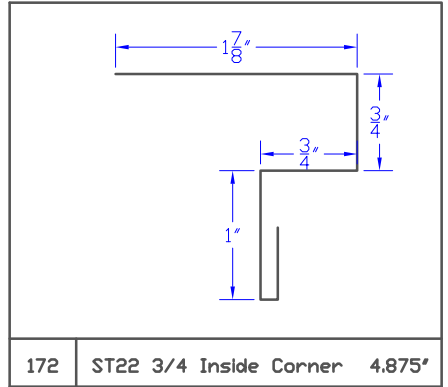
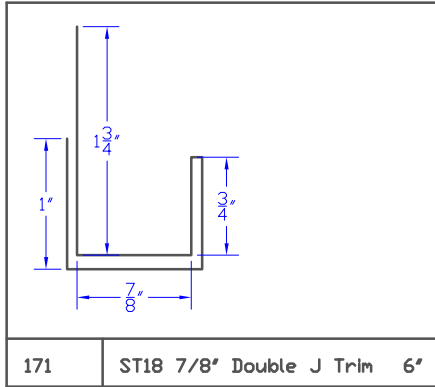
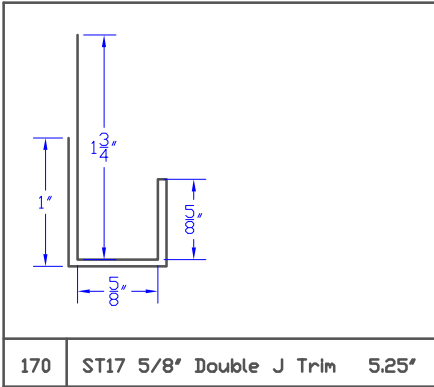
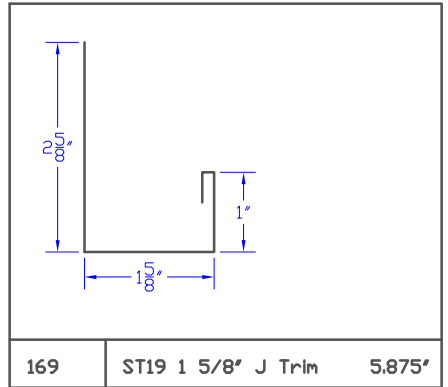
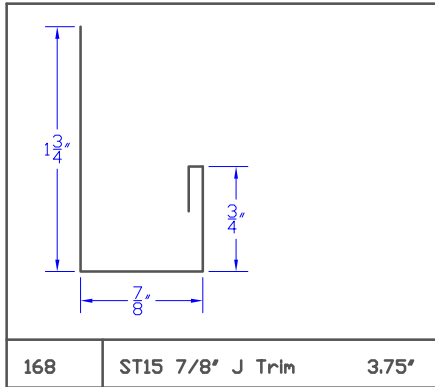
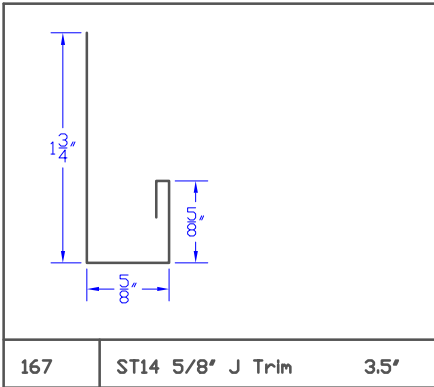

TS Metals

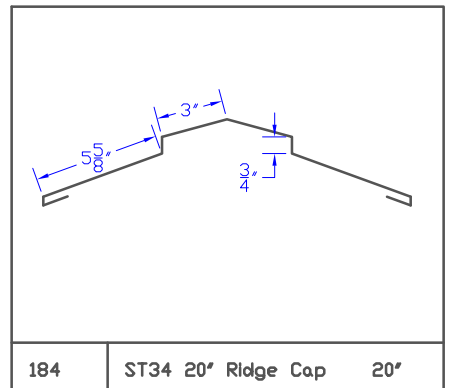
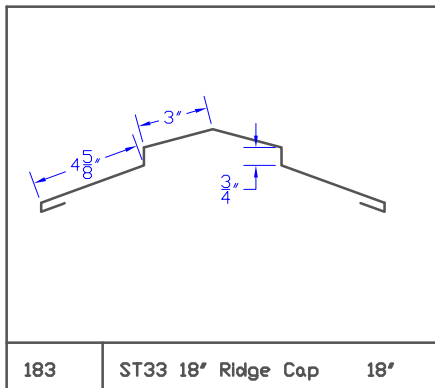
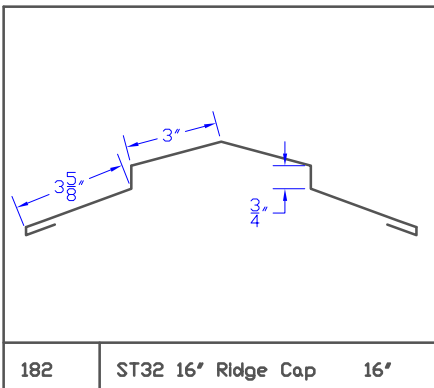
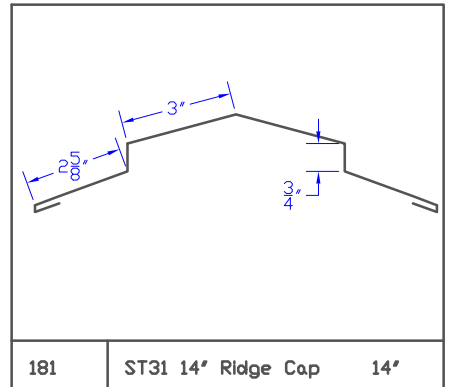
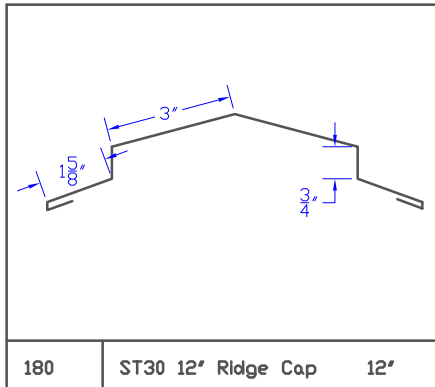
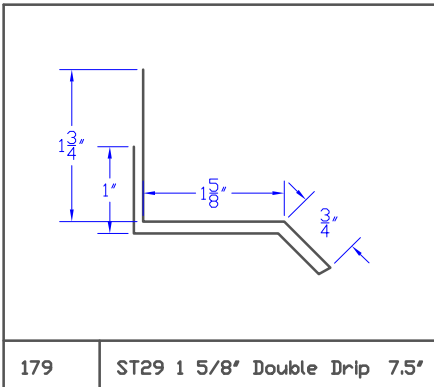
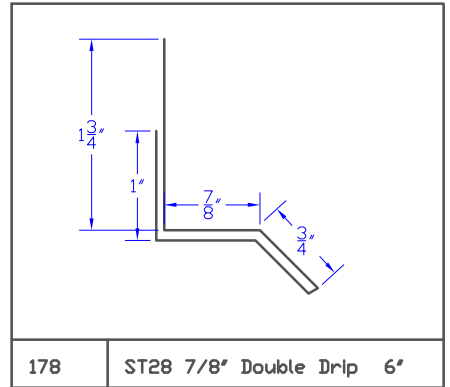
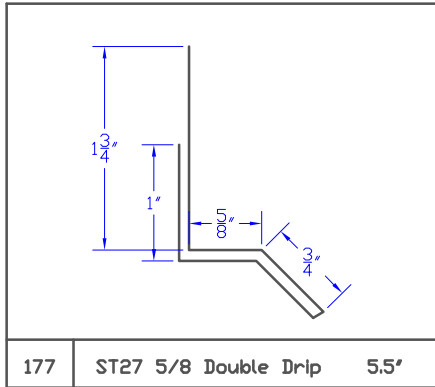
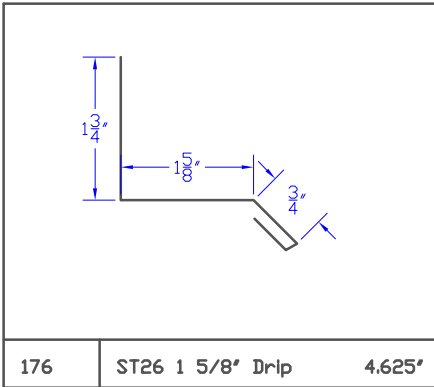

TS Metals

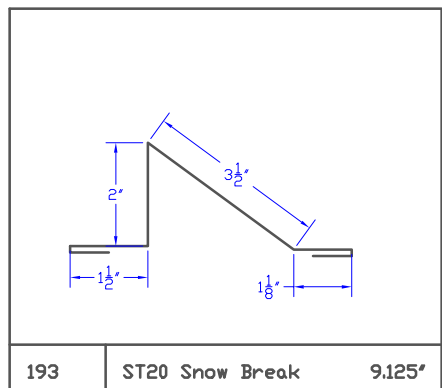
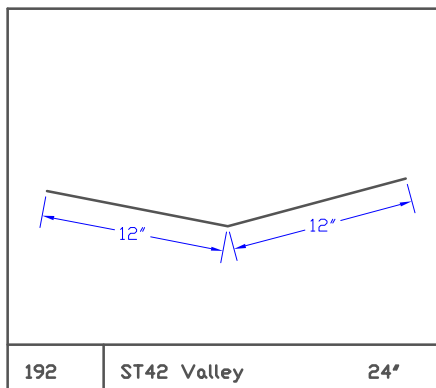
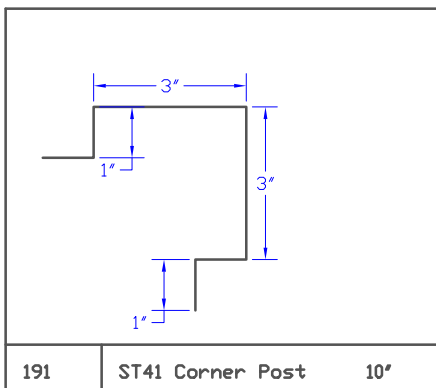
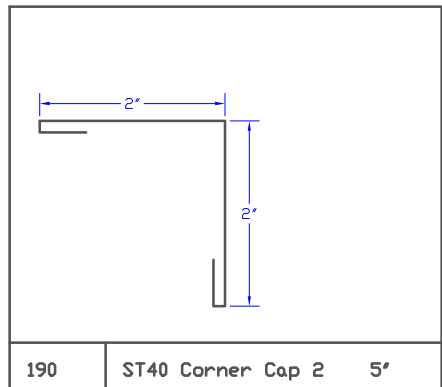
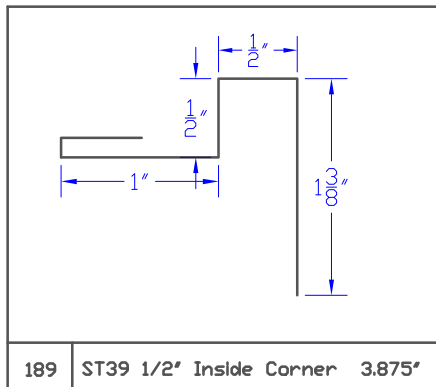
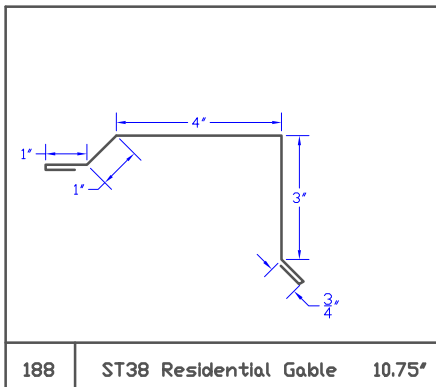
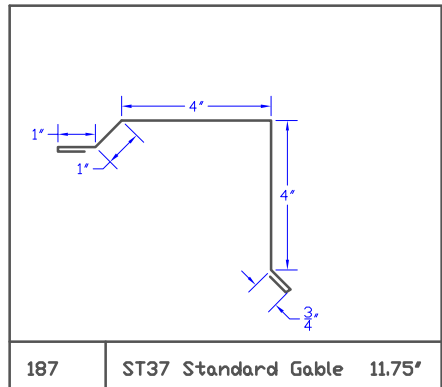
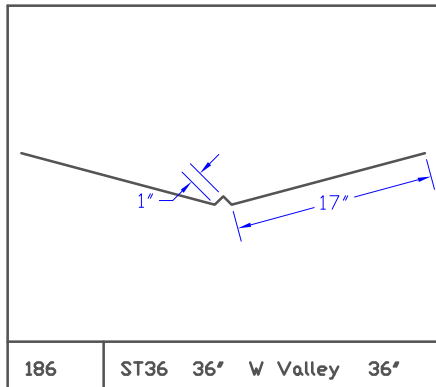
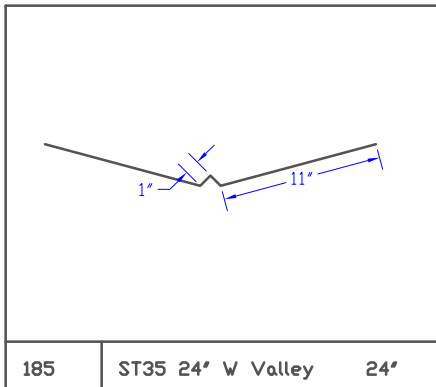

TS Metals

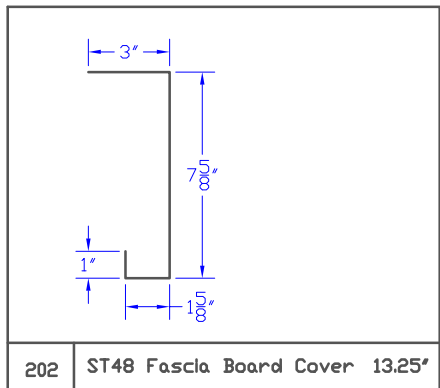
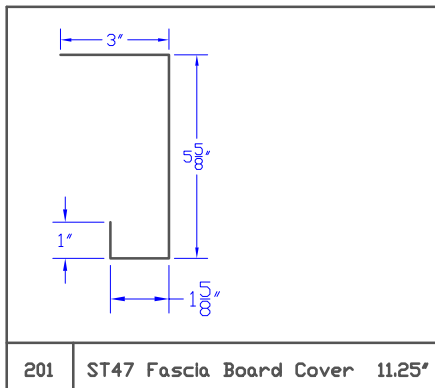
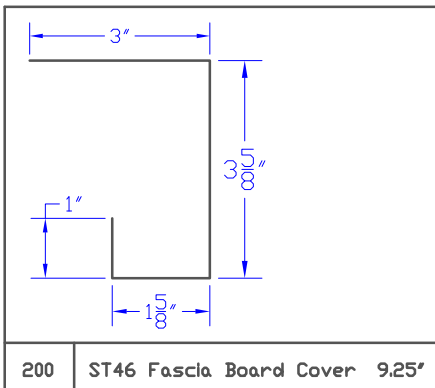
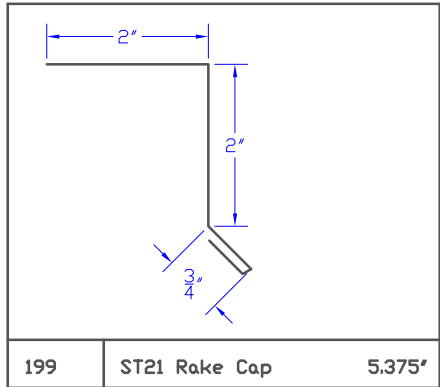
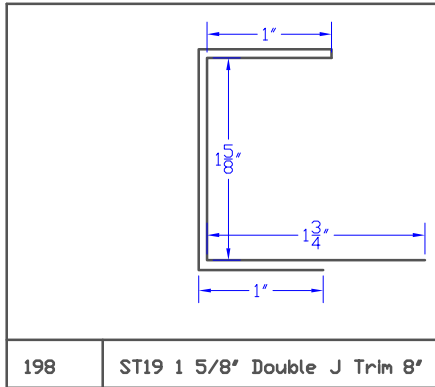
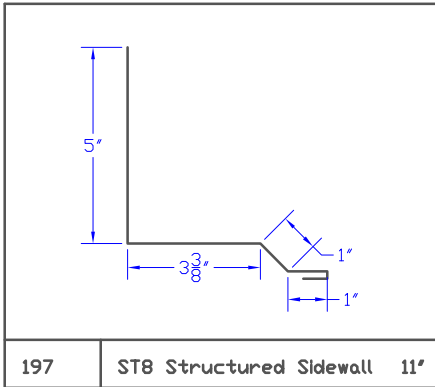
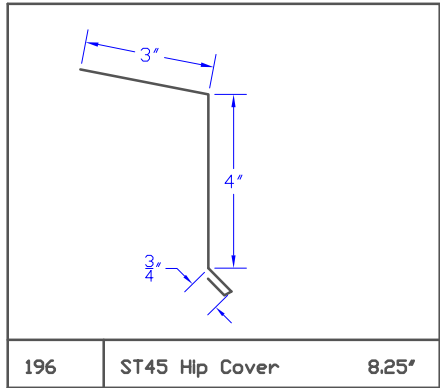
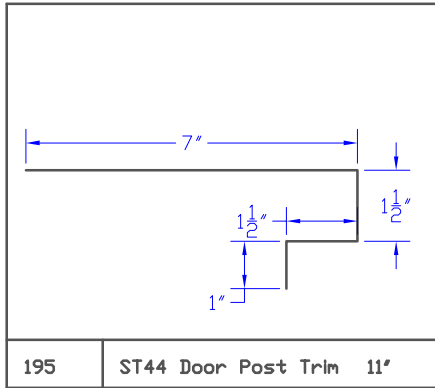
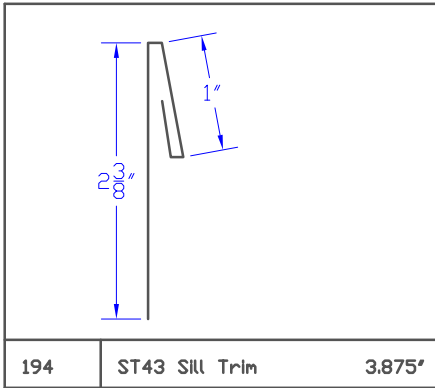

TS Metals

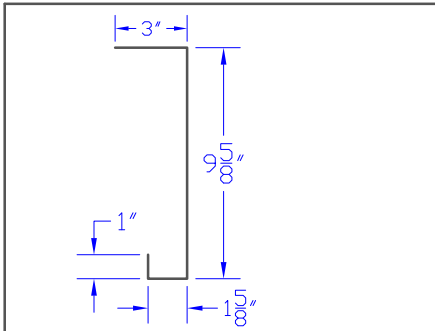

203 ST49 Fascia Board Cover 15.25'

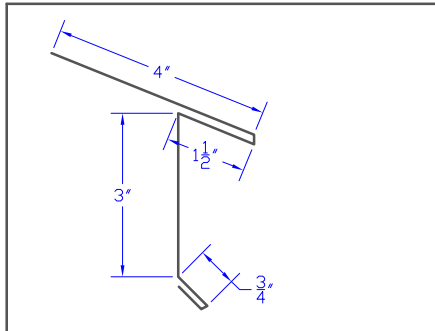

204 ST70 Extended Drip Edge 9.875'

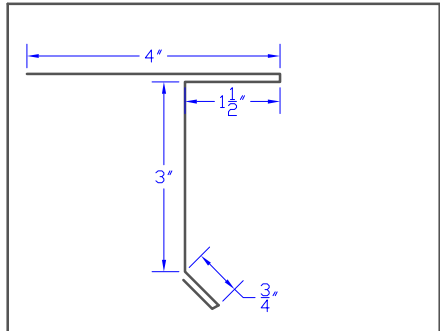

205 ST71 Extended Drip Edge 9.875'

